

Technical data sheet

Slide nut with spring ZL

Item number: 1147310



Slide nut with spring for use with MS4121 und MS4141 profile rails



St Steel

F Hot galvanized

Master data

Item number	1147310
Type	MS41SNF M8 F
Description 1	Slide nut with spring
Description 2	for profile rail MS4121/4141
Manufacturer	OBO
Dimension	M8
Material	Steel
Surface	Hot galvanized
Surface standard	DIN 267, Teil 10
Smallest sales unit	50
Unit of quantity	Piece
Weight	3.15 kg
Weight unit	kg/100 pc.

Technical data sheet

Slide nut with spring ZL

Item number: 1147310

Dimensions

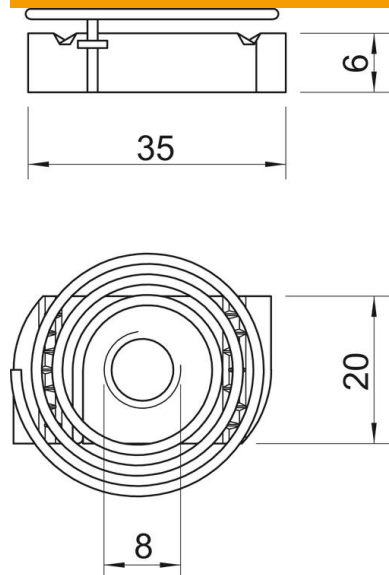

Length	35 mm
Width	20 mm
Height	6 mm

Technical data

Thread	M8
Thread metric	8
With spring	yes